

DESCRIPTION

- 240 MHz SAW bandpass filter with 7.6 MHz bandwidth.
- 13.3 x 6.5 mm SMP.
- RoHS compliant.

TYPICAL PERFORMANCE

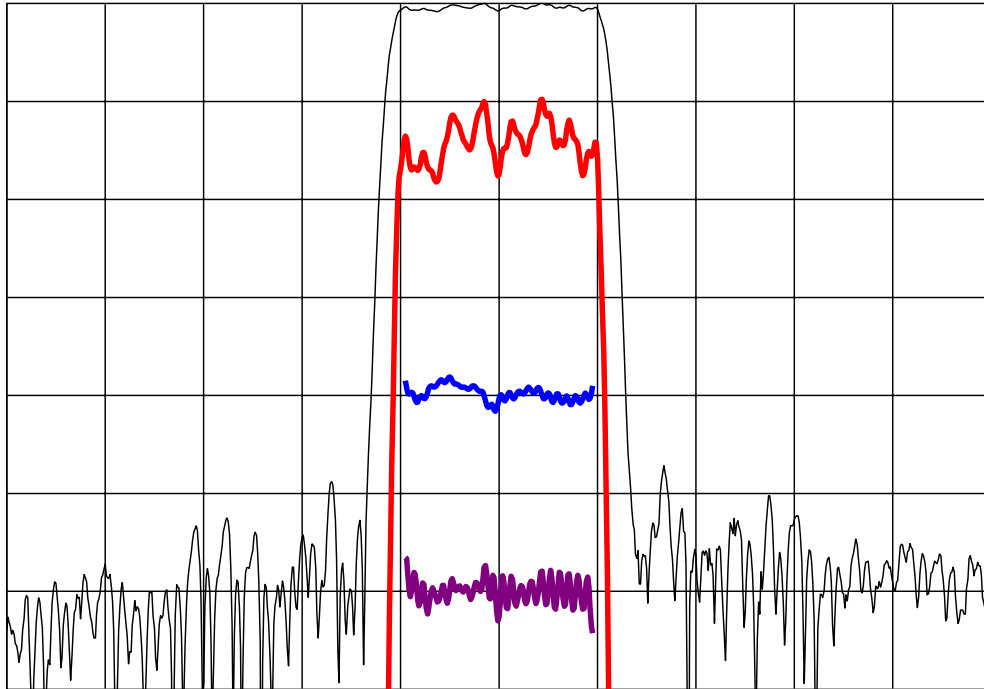

Horizontal: Frequency : 4 MHz/div
Vertical from Top: Relative Magnitude : 10 dB/div
Relative Magnitude : 1 dB/div
Phase Linearity : 10 deg/div
Group Delay Deviation : 100 ns/div

S11 (220-260 MHz)

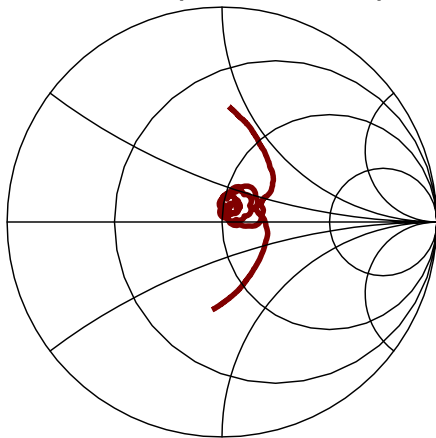

S22 (220-260 MHz)

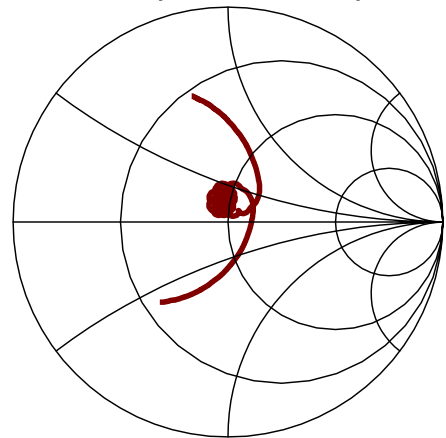

PACKAGE OUTLINE

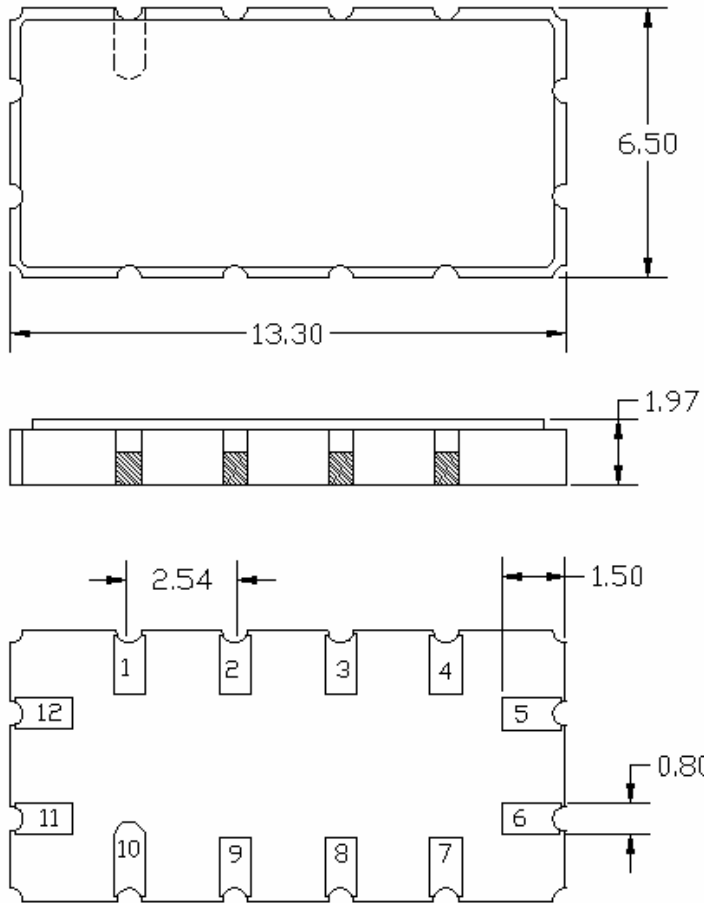

SUGGESTED FOOTPRINT

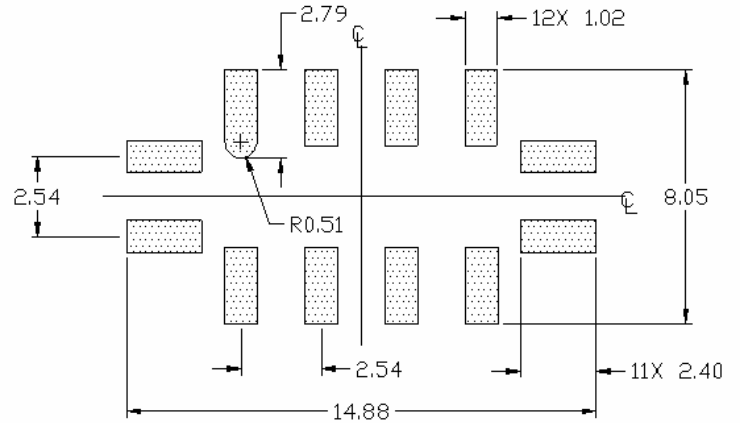

Units: mm

Tolerances are ± 0.15 mm except where indicated.

Pad Configuration:

Input: 11
Output: 5
Ground: All other pads

Package Material:
Body: Al_2O_3 ceramic
Lid: Kovar, Ni plated
Terminations: Au plating 1 μ m min,
over a 1.3-8.9 μ m Ni plating

ISO 9001
Registered

All specifications are believed to be accurate and reliable. However, Spectrum Microwave reserves the right to make changes without notice.
© 2010 All rights reserved.